

EQUILIBRIUM AND NON-EQUILIBRIUM DESCRIPTION OF NEGATIVE TEMPERATURE STATES IN A ONE- DIMENSIONAL LATTICE USING A WAVE KINETIC APPROACH

DAVIDE PROMENT,
UNIVERSITY OF EAST ANGLIA (UK)

Onorato, Dematteis, DP, Pezzi, Ballarin, and Rondoni

PRE 105, 014206 (2022)

EQUILIBRIUM AND NON-EQUILIBRIUM DESCRIPTION OF NEGATIVE TEMPERATURE STATES IN A ONE-DIMENSIONAL LATTICE USING A WAVE KINETIC APPROACH

- ▶ Negative temperature states
- ▶ Discrete nonlinear Schroedinger model (DNLS)
- ▶ Wave interaction and turbulence theory
- ▶ Our results and conclusions

HOW WE DEFINE TEMPERATURE?

- ▶ In a non-interactive (ideal) gas, the temperature is proportional to the average of the kinetic energy of the gas components
- ▶ Formally, temperature is only defined at equilibrium, that is for a classical gas when the Maxwell-Boltzmann distribution is reached
- ▶ At equilibrium, the energy per particle is $E_p = n \frac{1}{2} k_b T$
- ▶ In **statistical mechanics** temperature is more generally defined as

$$\frac{1}{T} = \frac{\partial S}{\partial E} \quad \Longrightarrow \quad T = \frac{1}{\frac{\partial S}{\partial E}}$$

HOW WE DEFINE TEMPERATURE?

- ▶ Usually, entropy is a monotonic growing function vs. energy and higher energies corresponds to higher temperatures
- ▶ However, some peculiar systems **shows the entropy decreasing after reaching a global maximum**

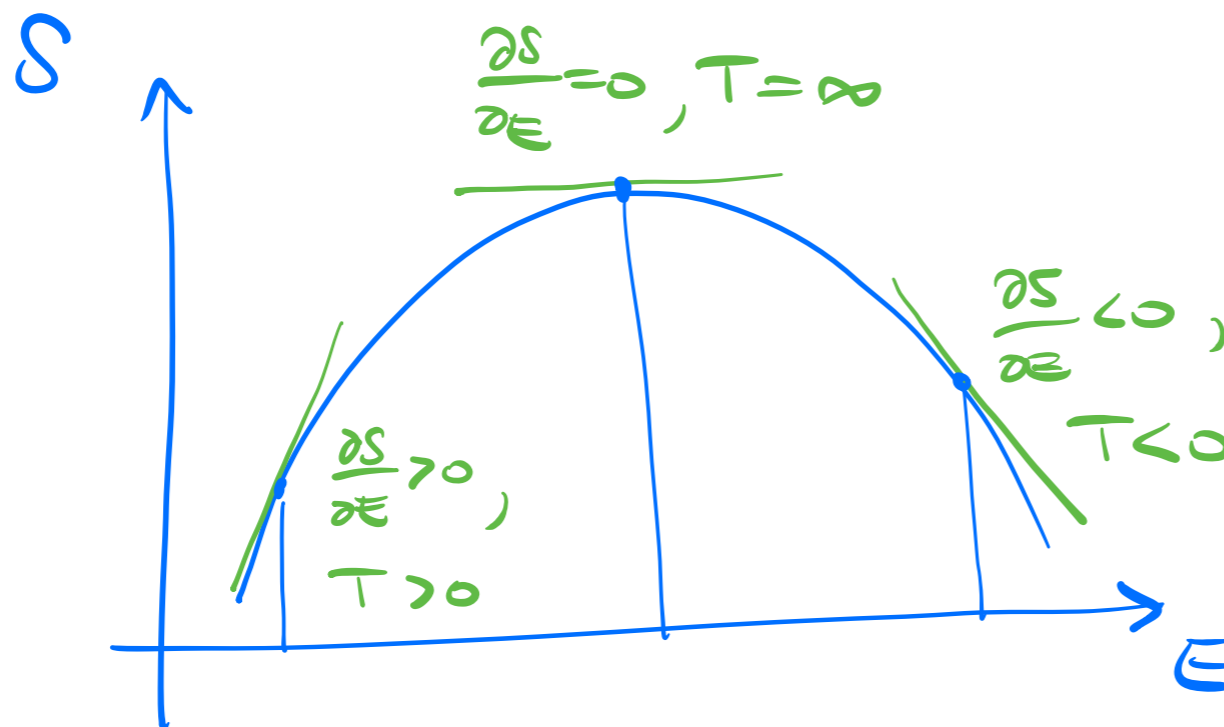

$$\frac{1}{T} = \frac{\partial S}{\partial E}$$

- ▶ Negative temperature states are thus “hotter states” as temperature first grows to infinity before becoming negative

SYSTEMS POSSESSING NEGATIVE TEMPERATURES

Non-interacting spin chain, $E = (N_+ - N_-) \mu B$

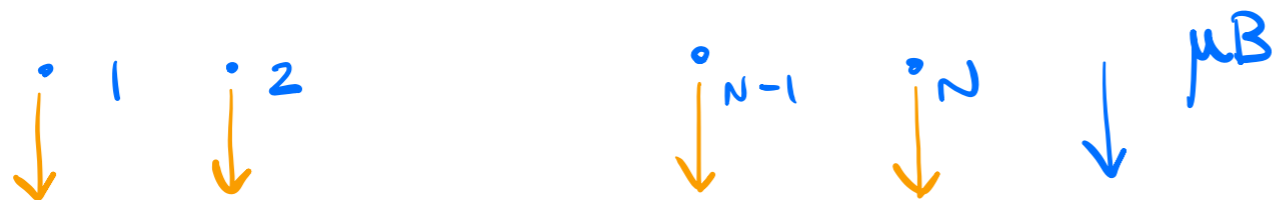

$$N_+ = 0, N_- = N$$

$$S = \ln(\Omega = 1) = 0, E = E_{\min}$$

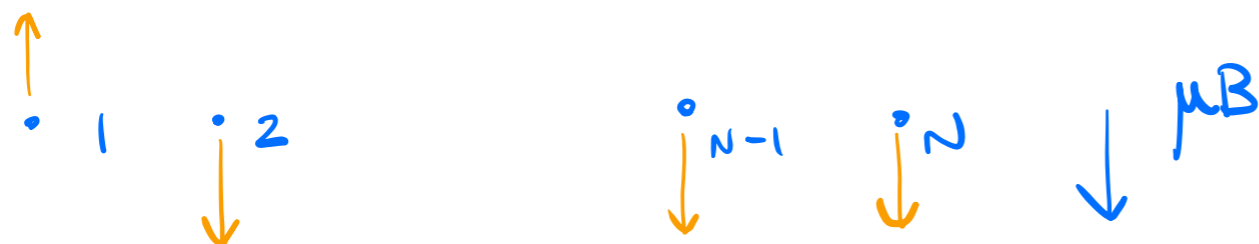

$$N_+ = 1, N_- = N - 1$$

$$S = \ln(\Omega = N), E > E_{\min}$$

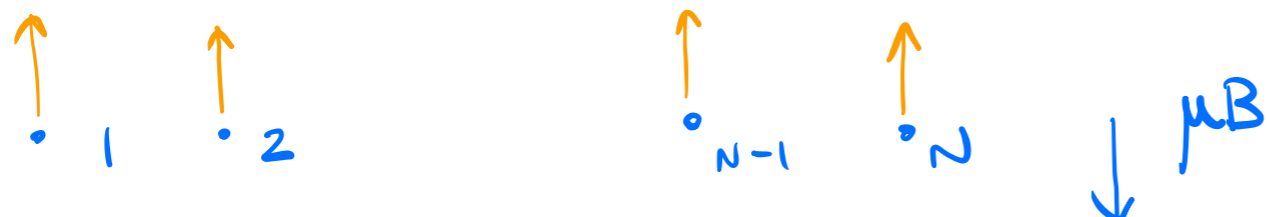

$$N_+ = N, N_- = 0$$

$$S = \ln(\Omega = 1) = 0, E = E_{\max}$$

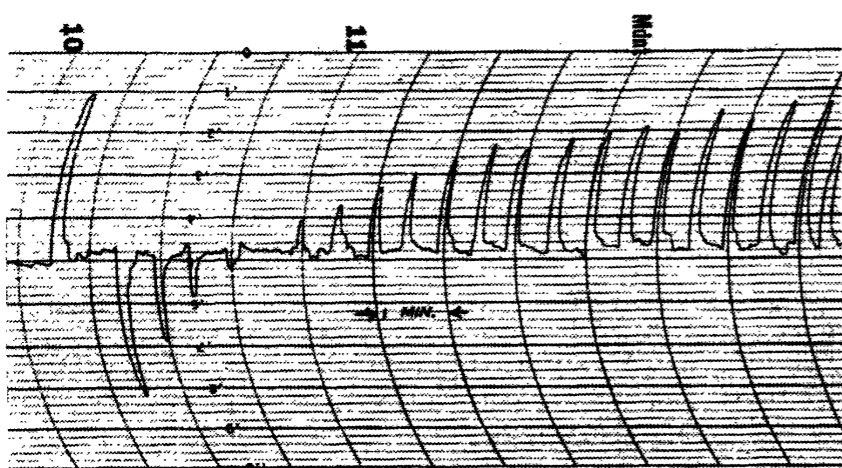

A Nuclear Spin System at Negative Temperature

E. M. PURCELL AND R. V. POUND

Department of Physics, Harvard University, Cambridge, Massachusetts

November 1, 1950

FIG. 1. A typical record of the reversed nuclear magnetization. On the left is a deflection characteristic of the normal state at equilibrium magnetization ($T \approx 300^\circ\text{K}$), followed by the reversed deflection ($T \approx -350^\circ\text{K}$), decaying ($T \rightarrow -\infty$) through zero deflection ($T = \infty$) to the initial equilibrium state.

[Purcell & Pound, *Physical Review* 81, 1951]

SYSTEMS POSSESSING NEGATIVE TEMPERATURES

Confined point vortex model

Statistical Hydrodynamics. (*)

L. ONSAGER

New Haven, Conn.

[Onsager, Il Nuovo Cimento 6, 1949]

Evolution of large-scale flow from turbulence in a two-dimensional superfluid

Shaun P. Johnstone^{1*}, Andrew J. Groszek^{1†}, Philip T. Starkey¹,
Christopher J. Billington^{1,2}, Tapio P. Simula^{1‡}, Kristian Helmerston^{1,3*}

[Johnstone et al., Science 364, 2019]

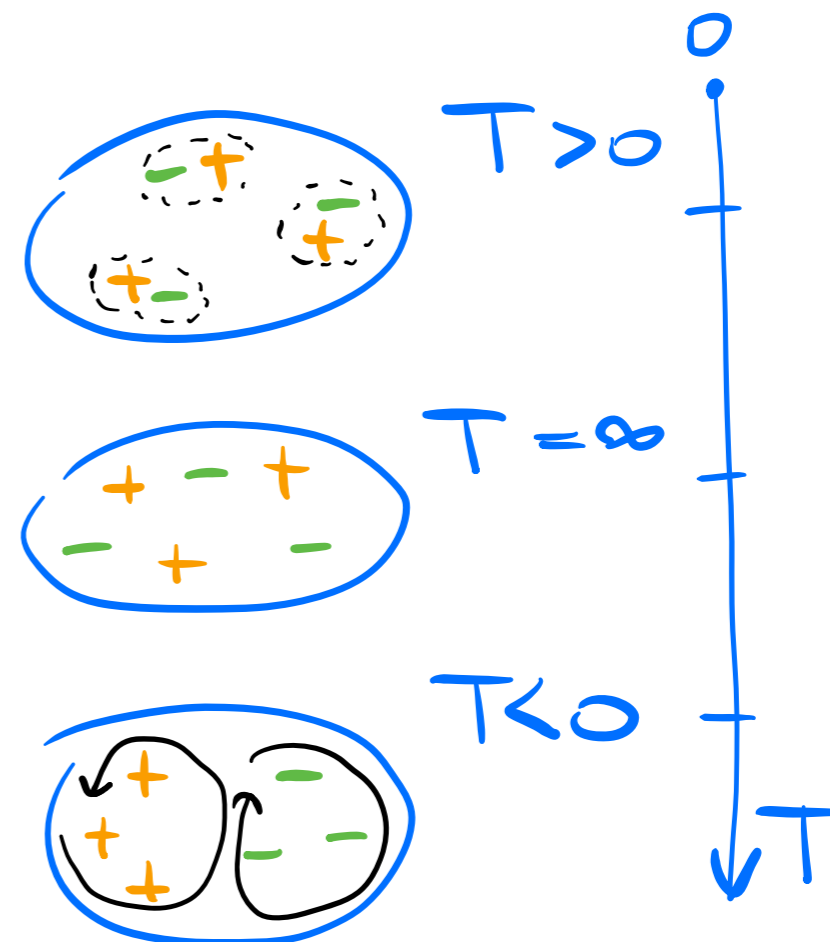

Giant vortex clusters in a two-dimensional quantum fluid

Guillaume Gauthier^{1*}, Matthew T. Reeves^{2*}, Xiaoquan Yu³, Ashton S. Bradley³,
Mark A. Baker¹, Thomas A. Bell¹, Halina Rubinsztein-Dunlop¹,
Matthew J. Davis², Tyler W. Neely^{1†}

[Gauthier et al., Science 364, 2019]

THE DISCRETE NONLINEAR SCHRÖDINGER EQUATION

The **discrete nonlinear Schrödinger** (DNLS) equation reads

$$i \frac{d\psi_m}{dt} + (\psi_{m+1} + \psi_{m-1} - 2\psi_m) + \nu |\psi_m|^2 \psi_m = 0, \quad m = 1, \dots, M$$

- ▶ ψ_m is the complex amplitude of the oscillator at site m
- ▶ **two conserved quantities**

$$H = \sum_{m=1}^M \left(|\psi_{m+1} - \psi_m|^2 - \frac{1}{2} \nu |\psi_m|^4 \right), \quad \text{energy}$$

$$N = \sum_{m=1}^M |\psi_m|^2, \quad \text{wave-action}$$

- ▶ (local) discretisation of the continuous one-dimensional NLS model $i\partial_t\psi + \nabla^2\psi + \nu|\psi|^2\psi = 0$, but **it is not an integrable model**

THE DISCRETE NONLINEAR SCHRÖDINGER EQUATION

The **discrete nonlinear Schrödinger** (DNLS) equation reads

$$i \frac{d\psi_m}{dt} + (\psi_{m+1} + \psi_{m-1} - 2\psi_m) + \nu |\psi_m|^2 \psi_m = 0, \quad m = 1, \dots, M$$

DNLS is **a very good model**, in the limit of tight-binding approximation, for

- ▶ lossless optical wave guide arrays
- ▶ Bose-Einstein condensates in optical traps

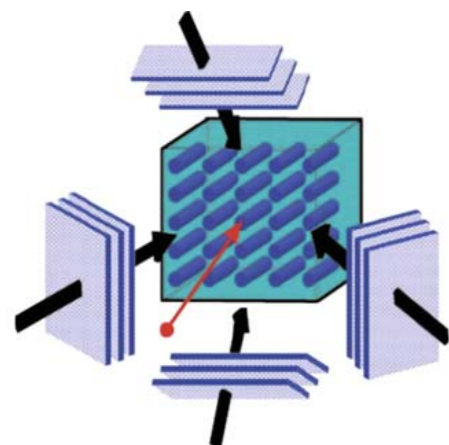
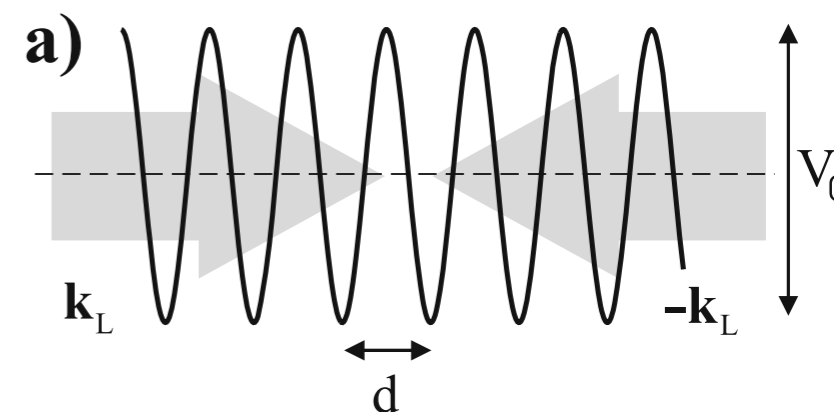
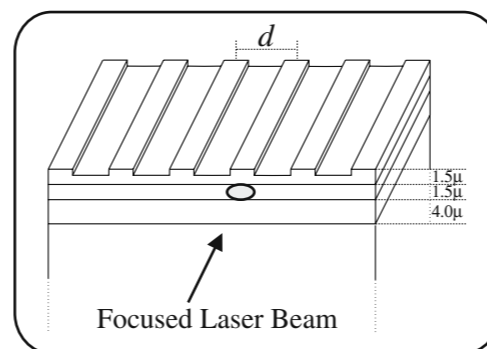

DNLS is also a qualitatively good model to describe some phenomena observed in photo refractive crystals

THE DISCRETE NONLINEAR SCHRÖDINGER EQUATION

Assuming periodic boundary conditions, and introducing discrete Fourier direct and inverse transforms

$$\psi_m = \sum_{k=1}^M \hat{\psi}_k e^{i2\pi km/M} \quad \text{and} \quad \hat{\psi}_k = \frac{1}{M} \sum_{m=1}^M \psi_m e^{-i2\pi km/M}$$

the DNLS becomes in **Fourier space**

$$i \frac{d\hat{\psi}_{k_1}}{dt} = \omega_{k_1} \hat{\psi}_{k_1} - \nu \sum_{k_2, k_3, k_4} \hat{\psi}_{k_2}^* \psi_{k_3} \psi_{k_4} \delta_{12}^{34}$$

where the dispersion relation is

$$\omega_k = 4 \sin^2(\pi k/M)$$

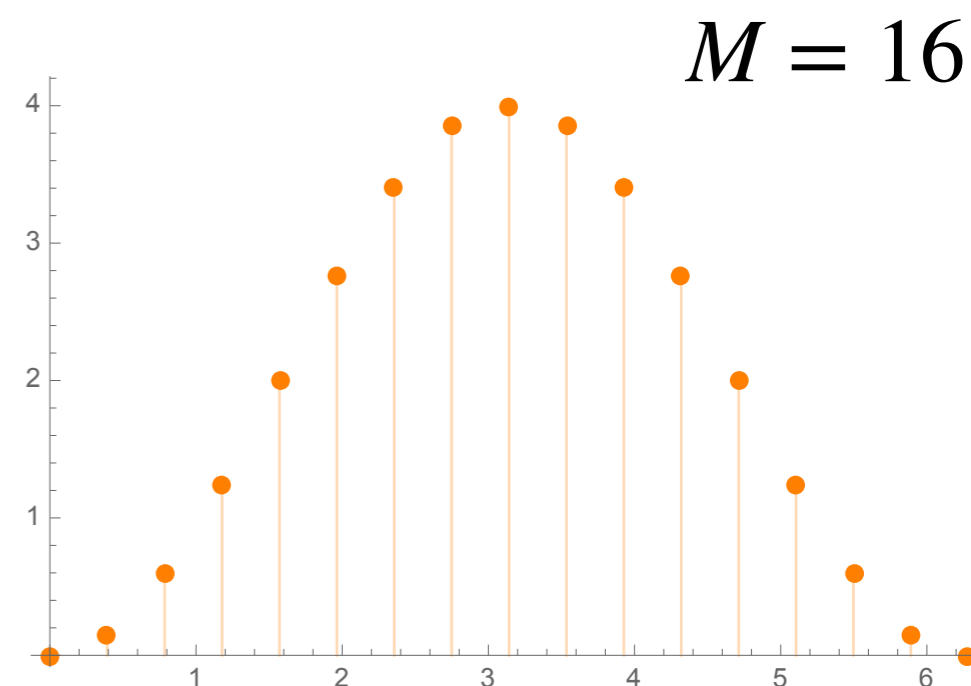

and the Kronecker's $\delta_{12}^{34} = \delta_{k_1+k_2, k_3+k_4}$ accounts for the **Umklapp scattering processes**, that is $k_1 + k_2, k_3 + k_4 \pmod{M}$

THE WAVE INTERACTION/TURBULENCE APPROACH

Wave turbulence (WT) theory is a statistical mechanics approach to weakly dispersive wave systems (waves in optics, plasma, ocean, Bose-Einstein condensates)

[Nazarenko, Wave Turbulence, 2011]



The (large time) **efficient energy transfer** in the system goes only through exact resonant n-wave interaction processes satisfying

$$k_1 \pm k_2 \pm \dots k_n = 0$$

$$\omega_1 \pm \omega_2 \pm \dots \omega_n = 0$$

(resonant manifold)

WT IN DNLS (ACTION-ANGLE VARIABLES)

$$i \frac{d\hat{\psi}_{k_1}}{dt} = \omega_{k_1} \hat{\psi}_{k_1} - \nu \sum_{k_2, k_3, k_4} \hat{\psi}_{k_2}^* \psi_{k_3} \psi_{k_4} \delta_{12}^{34}$$

Writing $\hat{\psi}_k = \sqrt{I_k} e^{-i\theta_k}$ in action-angle variables

$$\frac{dI_{k_1}}{dt} = -2\nu \sum_{k_2, k_3, k_4} \sqrt{I_{k_1} I_{k_2} I_{k_3} I_{k_4}} \sin(\Delta\theta_{12}^{34}) \delta_{12}^{34}$$

$$\frac{d\theta_{k_1}}{dt} = \omega_{k_1} - \nu \sum_{k_2, k_3, k_4} \sqrt{\frac{I_{k_2} I_{k_3} I_{k_4}}{I_{k_1}}} \cos(\Delta\theta_{12}^{34}) \delta_{12}^{34}$$

where $\Delta\theta_{12} = \theta_1 + \theta_2 - \theta_3 - \theta_4$

WT IN DNLS ($M \rightarrow \infty$ AND KINETIC EQUATION)

- ▶ **Statistical approach**, averaging over realisations having phases uniformly distributed $\theta_k \in [0, 2\pi)$
- ▶ Consider weakly nonlinear limit, that is $|\nu| \ll 1$
- ▶ First non zero moment is the **wave-action density** $n_k(t) \propto \langle I_k \rangle$
- ▶ Take the thermodynamic (large box) limit $M \rightarrow \infty$
- ▶ At a large time-scale τ

$$\frac{dn_{k_1}}{d\tau} = 4\pi\nu^2 \int_0^{2\pi} n_{k_1} n_{k_2} n_{k_3} n_{k_4} \left(\frac{1}{n_{k_1}} + \frac{1}{n_{k_2}} - \frac{1}{n_{k_3}} - \frac{1}{n_{k_4}} \right)$$

$$\delta(\Delta\omega_{12}^{34}) \delta_{12}^{34} dk_2 dk_3 dk_4,$$

where $\Delta\omega_{12} = \omega_1 + \omega_2 - \omega_3 - \omega_4$,
 $k \in [0, 2\pi]$ and $\omega_k = 4 \sin^2(k/2)$

[Onorato & Dematteis, JPC 4, 2020]

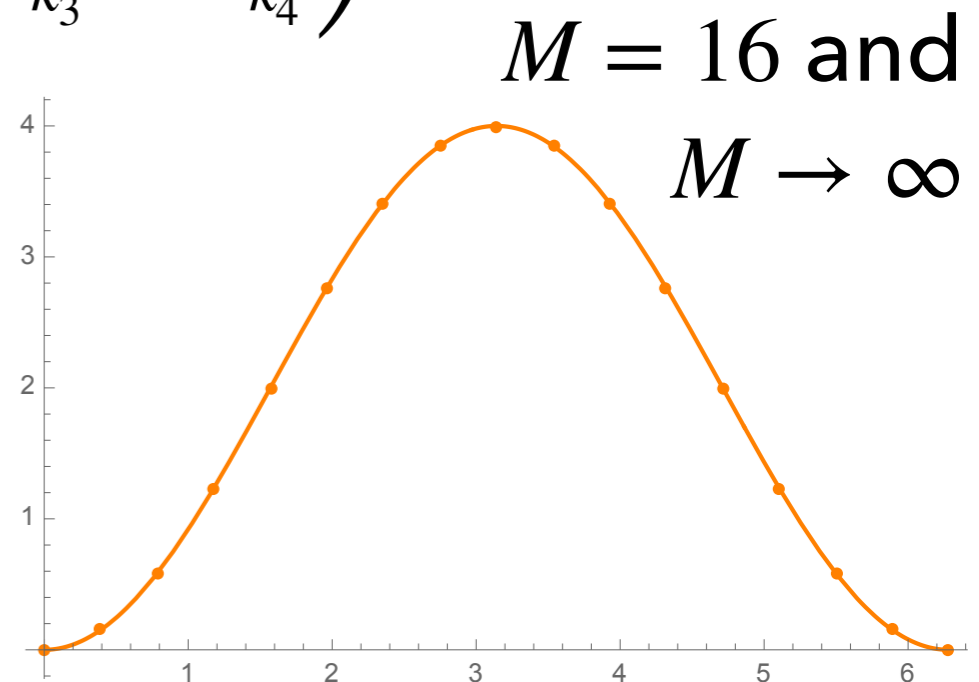

WT IN DNLS ($M \rightarrow \infty$ AND KINETIC EQUATION)

- ▶ 4-wave interactions
- ▶ resonant manifold given by

$$k_1 + k_2 - k_3 - k_4 = 0 \pmod{2\pi}$$
$$\omega_1 + \omega_2 - \omega_3 - \omega_4 = 0$$

$$\frac{dn_{k_1}}{d\tau} = 4\pi\nu^2 \int_0^{2\pi} n_{k_1} n_{k_2} n_{k_3} n_{k_4} \left(\frac{1}{n_{k_1}} + \frac{1}{n_{k_2}} - \frac{1}{n_{k_3}} - \frac{1}{n_{k_4}} \right)$$

$$\delta(\Delta\omega_{12}^{34}) \delta_{12}^{34} dk_2 dk_3 dk_4,$$

where $\Delta\omega_{12} = \omega_1 + \omega_2 - \omega_3 - \omega_4$,
 $k \in [0, 2\pi]$ and $\omega_k = 4 \sin^2(k/2)$

[Onorato & Dematteis, JPC 4, 2020]

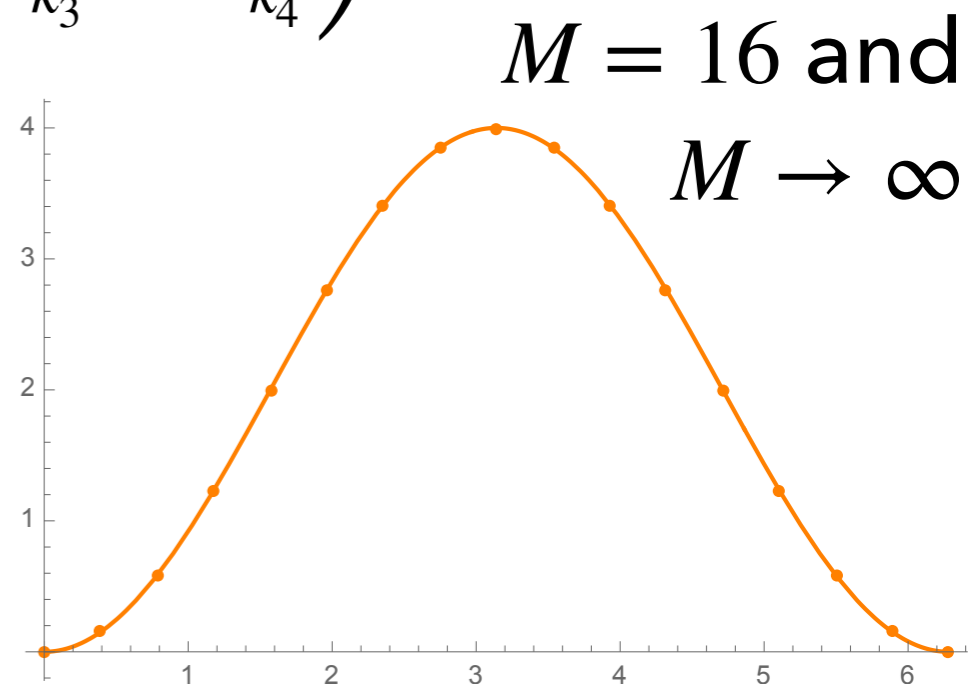

WT IN DNLS (TAKING THE THERMODYNAMIC LIMIT)

$$\frac{dn_{k_1}}{d\tau} = 4\pi\nu^2 \int_0^{2\pi} n_{k_1} n_{k_2} n_{k_3} n_{k_4} \left(\frac{1}{n_{k_1}} + \frac{1}{n_{k_2}} - \frac{1}{n_{k_3}} - \frac{1}{n_{k_4}} \right) \delta(\Delta\omega_{12}^{34}) \delta_{12}^{34} dk_2 dk_3 dk_4$$

- ▶ Two invariants

$$E = \int_0^{2\pi} \omega_k n_k dk \quad \text{and} \quad N = \int_0^{2\pi} n_k dk$$

- ▶ **KE is time-irreversible** as, given the entropy $S(t) = \int_0^{2\pi} \ln n_k(t) dk$, an H-theorem $dS/dt \geq 0$ holds
- ▶ The equilibrium is the **Rayleigh-Jeans distribution** (T, μ)

$$n_k^{(RJ)} = \frac{T}{\omega_k - \mu} = \frac{1}{\beta\omega_k - \gamma} \quad \text{with} \quad \beta = 1/T, \gamma = \mu/T$$

RJ AND NEGATIVE TEMPERATURE STATES

$$n_k^{(RJ)} = \frac{T}{\omega_k - \mu} = \frac{1}{\beta\omega_k - \gamma} \quad \text{with} \quad \beta = 1/T, \gamma = \mu/T$$

- ▶ Play with T and μ to have negative temperatures, $T < 0$, but still a positive-defined distribution
- ▶ energy density distribution $e_k = \omega_k n_k$

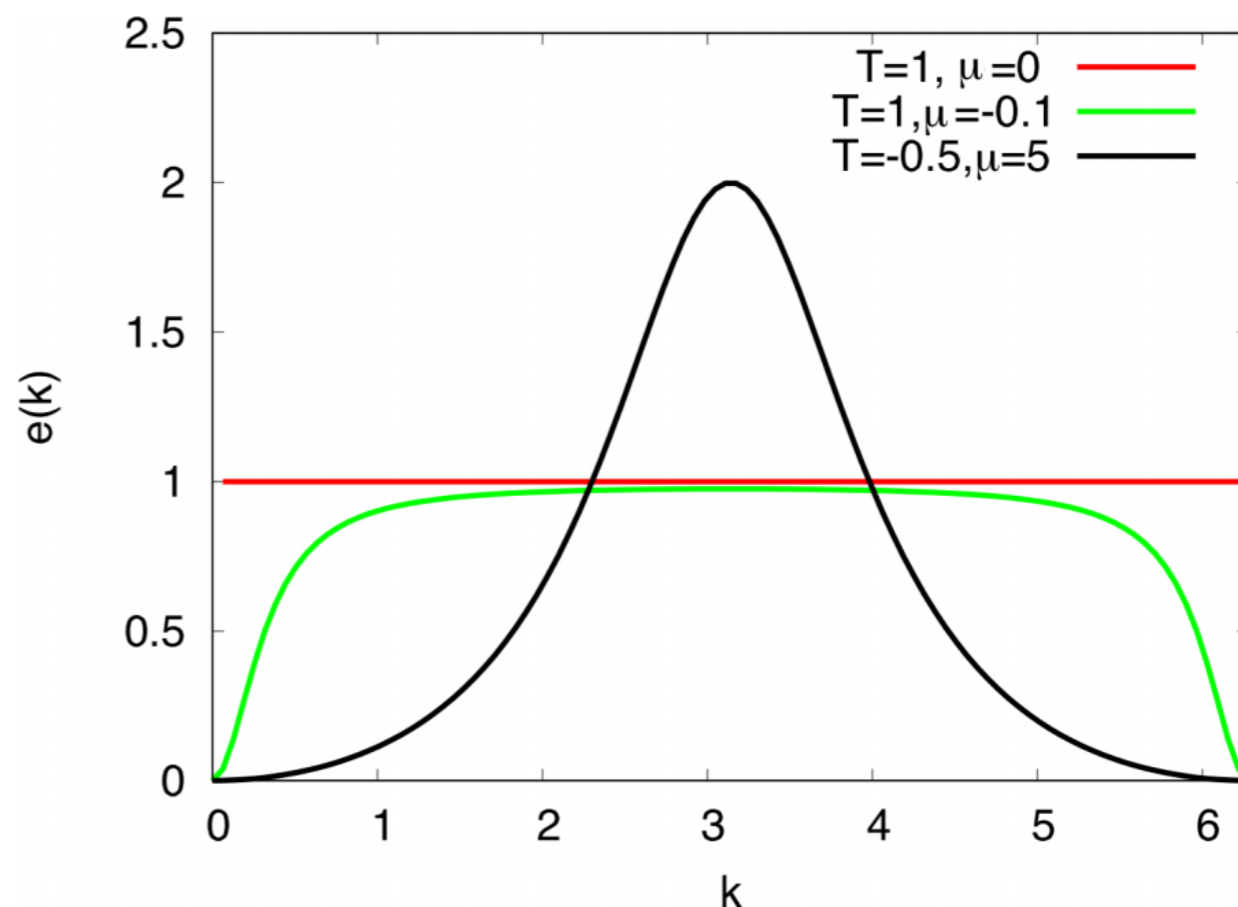

FIG. 1. Spectral energy density $e(k) = \omega(k)n(k)$ for different temperatures and chemical potentials. The red horizontal line is the typical equipartition of energy and corresponds to $T = 1$ and $\mu = 0$; the green line corresponds to $T = 1$ and $\mu = -0.1$ and the black line (sharply peaked around $k = \pi$) corresponds to negative temperatures, i.e., $T = -0.5$ and $\mu = 5$. All these curves are exact stationary solutions of the WK equation.

LINKING INTENSIVE AND EXTENSIVE QUANTITIES

$$E = \int_0^{2\pi} \omega_k n_k dk, \quad N = \int_0^{2\pi} n_k dk \quad \text{and} \quad S(t) = \int_0^{2\pi} \ln n_k(t) dk$$

Given the RJ distribution $n_k^{(RJ)} = \frac{1}{\beta\omega_k - \gamma}$, one can obtain

$$\beta(E, N) = \frac{4\pi(E - 2N)}{E(E - 4N)}$$

$$\gamma(E, N) = \frac{2\pi E}{N(E - 4N)}$$

$$S(E, N) = 2\pi \ln \left[\frac{E(4N - E)}{8\pi N} \right]$$

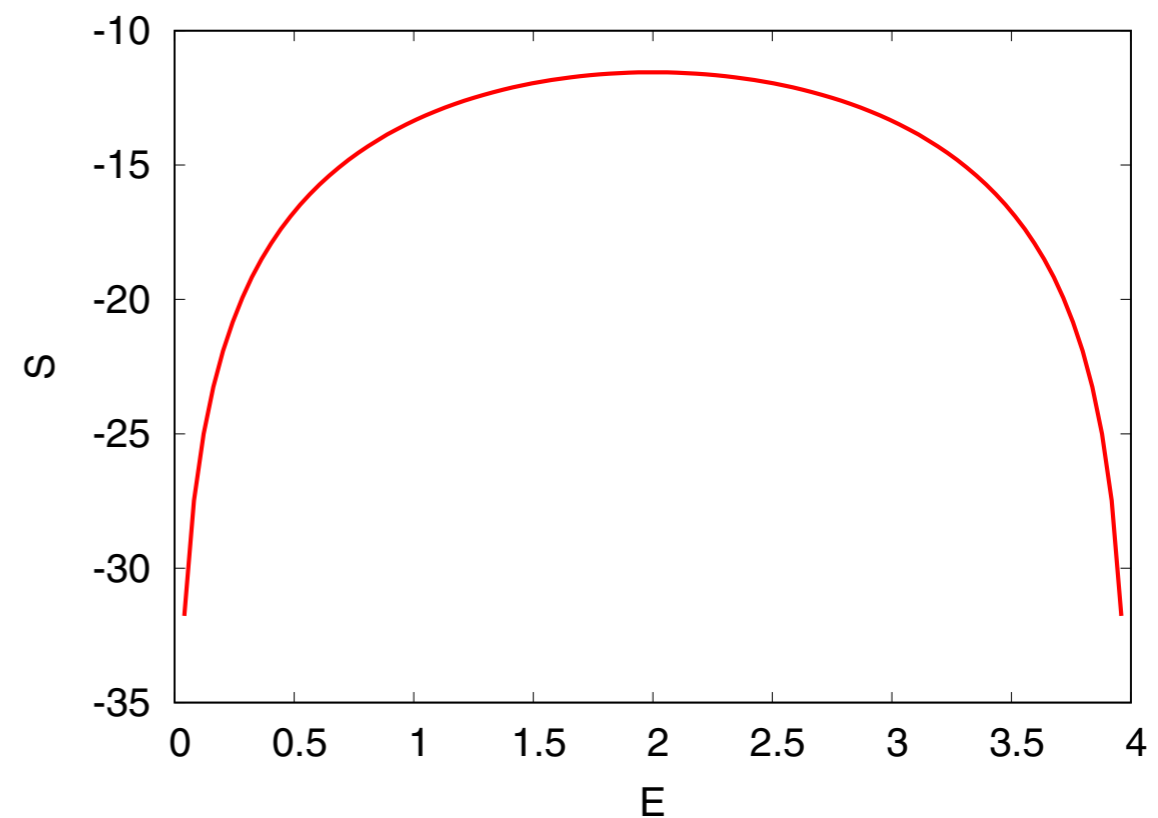

FIG. 3. The entropy, S , as a function of the energy, E , for $N = 1$. The derivative of S is the inverse of the temperature. For $E > 2N=2$ the derivative is negative, implying a negative temperature. Note that entropy is defined for $0 < E < 4N$.

LINKING INTENSIVE AND EXTENSIVE QUANTITIES

$$E = \int_0^{2\pi} \omega_k n_k dk, \quad N = \int_0^{2\pi} n_k dk \quad \text{and} \quad S(t) = \int_0^{2\pi} \ln n_k(t) dk$$

Given the RJ distribution $n_k^{(RJ)} = \frac{1}{\beta\omega_k - \gamma}$, one can obtain

$$\beta(E, N) = \frac{4\pi(E - 2N)}{E(E - 4N)}$$

$$\gamma(E, N) = \frac{2\pi E}{N(E - 4N)}$$

$$S(E, N) = 2\pi \ln \left[\frac{E(4N - E)}{8\pi N} \right]$$

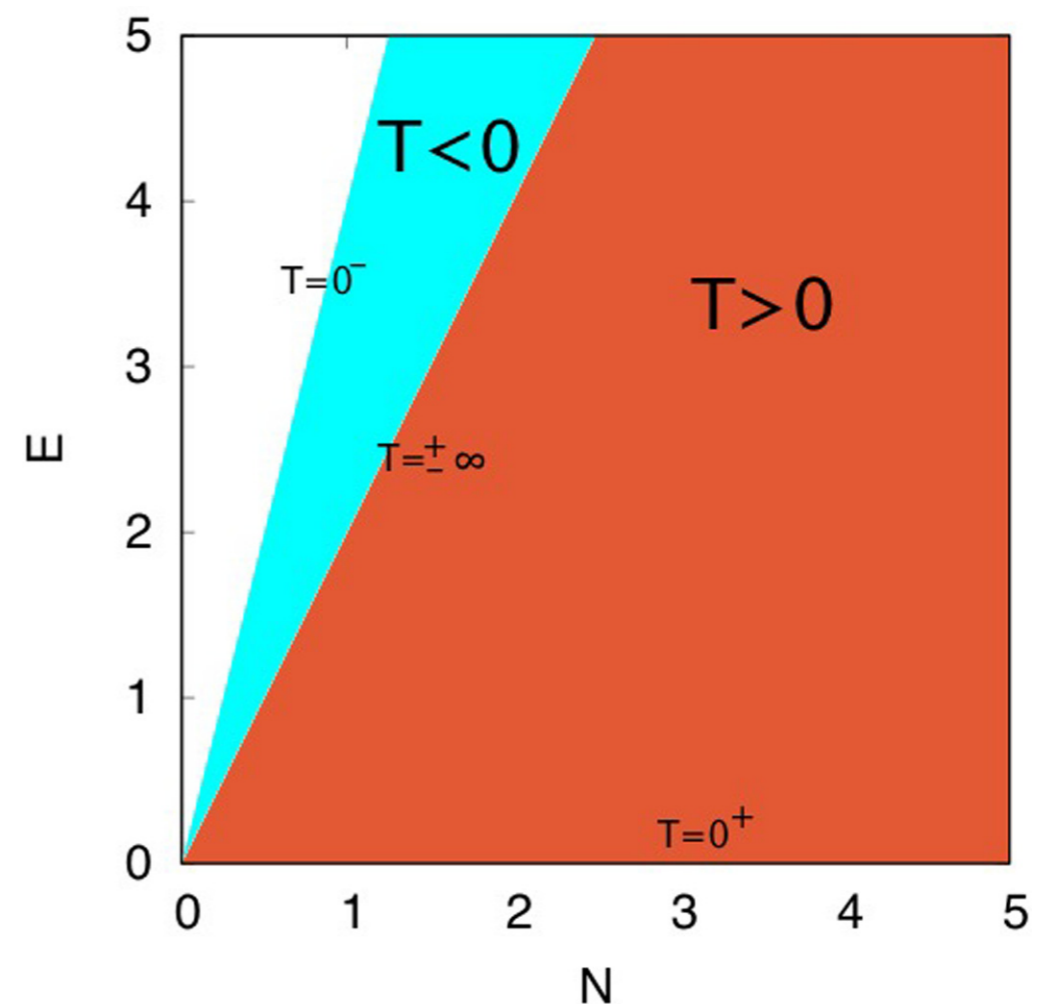

DIRECT NUMERICAL SIMULATIONS OF THE DNLS MODEL

$$i \frac{d\psi_m}{dt} + (\psi_{m+1} + \psi_{m-1} - 2\psi_m) + \nu |\psi_m|^2 \psi_m = 0, \quad m = 1, \dots, M$$

- ▶ Can we obtain negative temperature states?
- ▶ Are the predictions of the wave kinetic equation accurate?

DIRECT NUMERICAL SIMULATIONS OF THE DNLS MODEL

$$i \frac{d\psi_m}{dt} + (\psi_{m+1} + \psi_{m-1} - 2\psi_m) + \nu |\psi_m|^2 \psi_m = 0, \quad m = 1, \dots, M$$

- ▶ Solve DNLS using a standard fourth-order RK algorithm that preserves (sufficiently well) the conserved quantities for large time-scales
- ▶ Average over 1,000 realisations initialised with the same spectral density but phases randomly distributed $\theta_k \in [0, 2\pi)$

NUMERICAL RESULTS: RJ EQUILIBRIUM

initial wave-action distribution

$$n_k = B + A \exp \left\{ \frac{-[(k - k_0)\Delta k]^2}{2\sigma^2} \right\}$$

with $\sigma = 0.9$, $A = 2$, $B = 0$, $\Delta k = 2\pi/M$, $M = 512$, and $k_0 = M/2$. With this choice $E = \sum \omega_k n_k \Delta k = 18.80$ and $N = \sum n_k \Delta k = 5.63$; therefore $2N < E < 4N$ which corresponds to $T = -0.74$ and $\mu = 4.16$, i.e., negative temperatures. One thousand realizations of the same spectrum (deterministic amplitudes) with different random phases have been considered and the results are obtained by averaging over the ensemble. The nonlinear parameter ν was set to 0.03. In

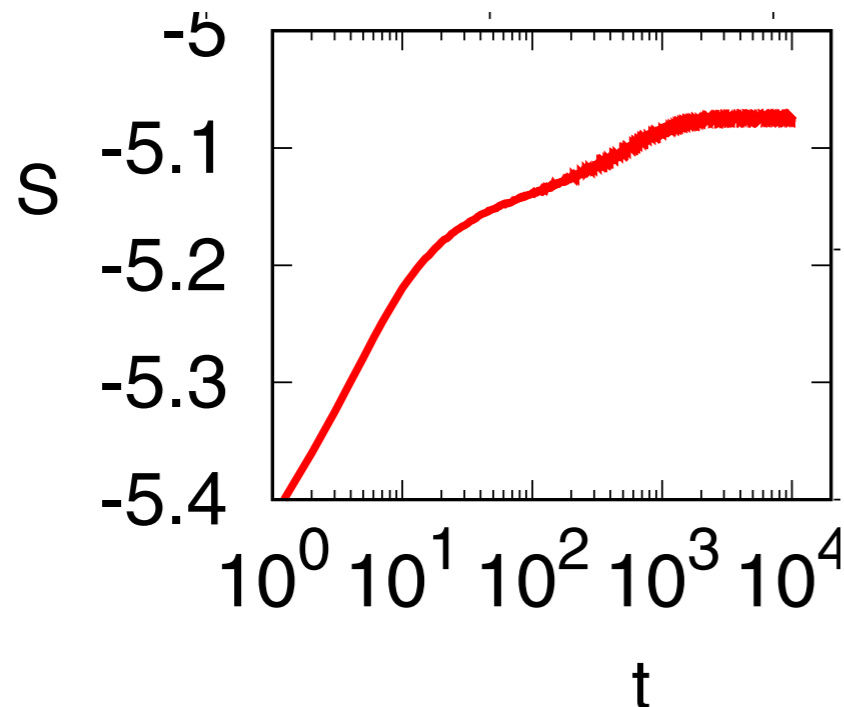

$$e_k = \langle \omega_k n_k \rangle$$

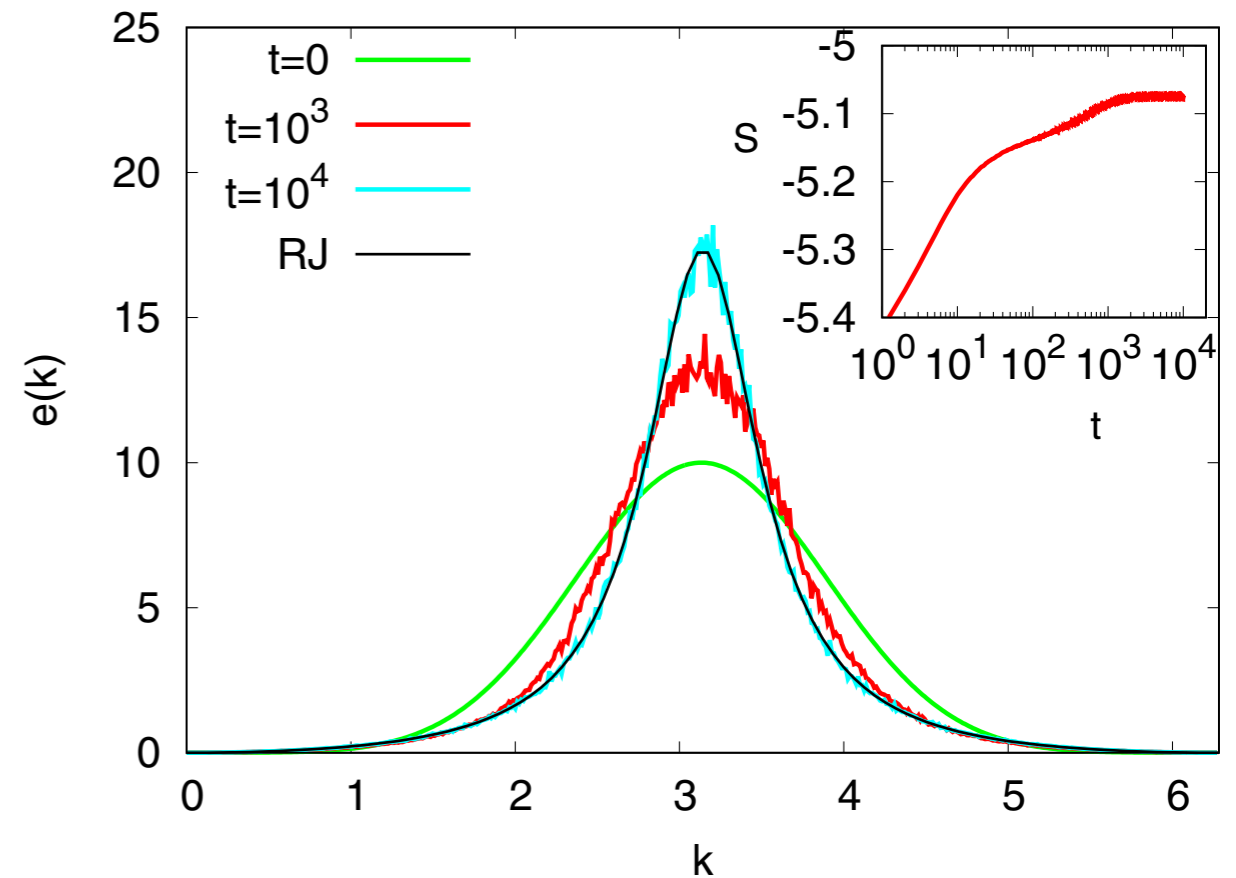

FIG. 4. Energy density as a function of wave number for a simulation of the DNLS equation characterized by the initial condition in (30) that corresponds to $T = -0.74$ and $\mu = 4.16$. Note that, because of the conservation of energy and number of particles, temperature and chemical potential do not change in time [44,45].

$$S(t) = \left\langle \int_0^{2\pi} \ln n_k(t) dk \right\rangle$$

NUMERICAL RESULTS: FLUCTUATIONS

The WT theory also allows to derive higher order moments of the angle-action variables, for example the second moment $\Lambda_k \propto \langle I_k^2 \rangle$

$$\frac{d\Lambda_{k_1}}{d\tau} = 4n_{k_1}\xi_{k_1} - 2\gamma_{k_1}\Lambda_{k_1} \quad \text{with}$$

$$\xi_{k_1} = 4\pi\nu^2 \int_0^{2\pi} n_{k_2} n_{k_3} n_{k_4} \delta(\Delta\omega_{12}^{34}) \delta_{12}^{34} dk_2 dk_3 dk_4$$

$$\gamma_{k_1} = -4\pi\nu^2 \int_0^{2\pi} (n_{k_3} n_{k_4} - n_{k_2} n_{k_3} - n_{k_2} n_{k_4}) \delta(\Delta\omega_{12}^{34}) \delta_{12}^{34} dk_2 dk_3 dk_4$$

One can check that if $\Lambda_k(t) = 2n_k^2(t)$, then the top equation is always satisfied provided that $n_k(t)$ follows the KE described before. **One can then test this relation!**

NUMERICAL RESULTS: FLUCTUATIONS

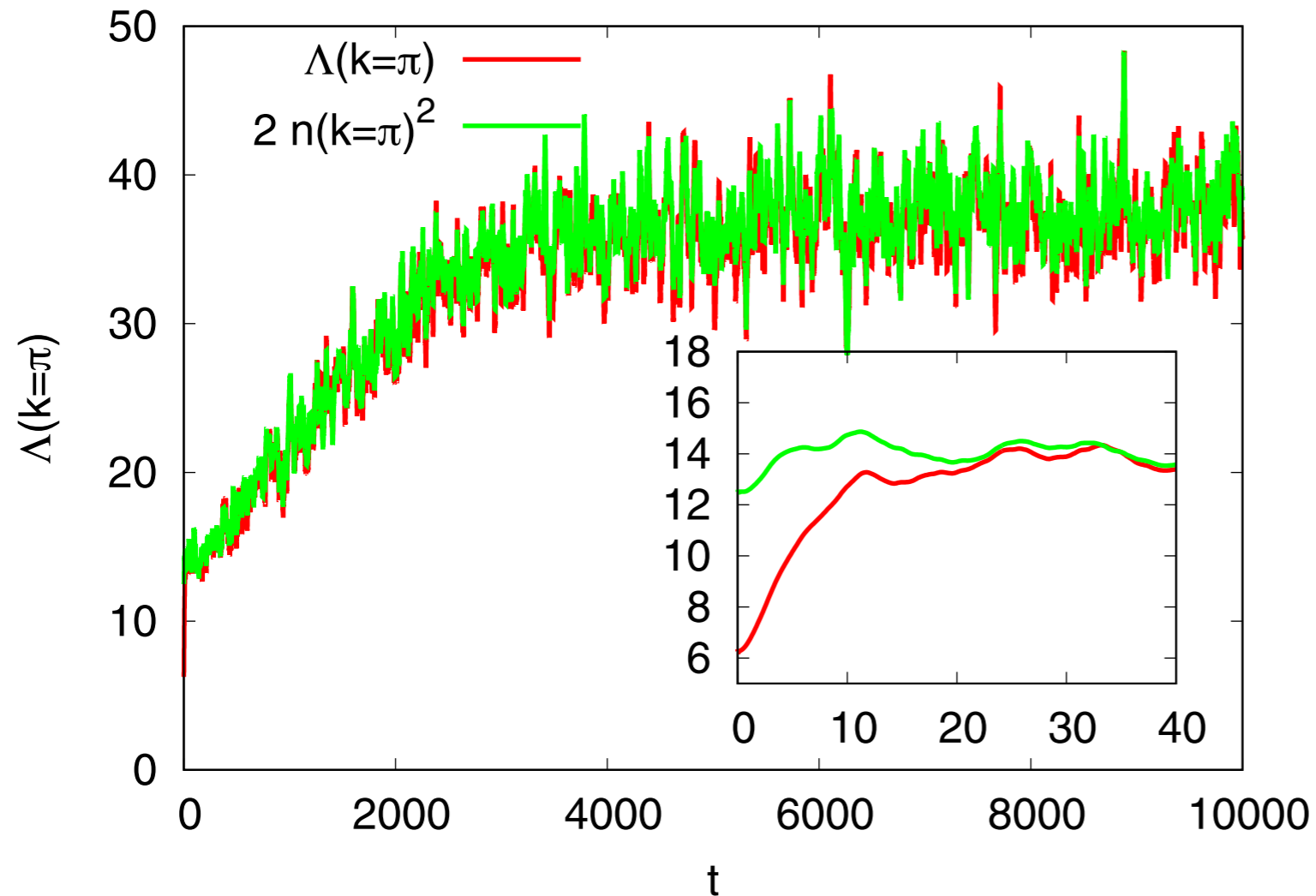

- ▶ We tested it for the mode $k = \pi$ in the negative temperature regime
- ▶ The higher-order moment $\langle I_k \rangle$ starts to follow the kinetic theory **at very short time-scale**

One can check that if $\Lambda_k(t) = 2 n_k^2(t)$, then the top equation is always satisfied provided that $n_k(t)$ follows the KE described before. **One can then test this relation!**

NUMERICAL RESULTS: FLUCTUATIONS

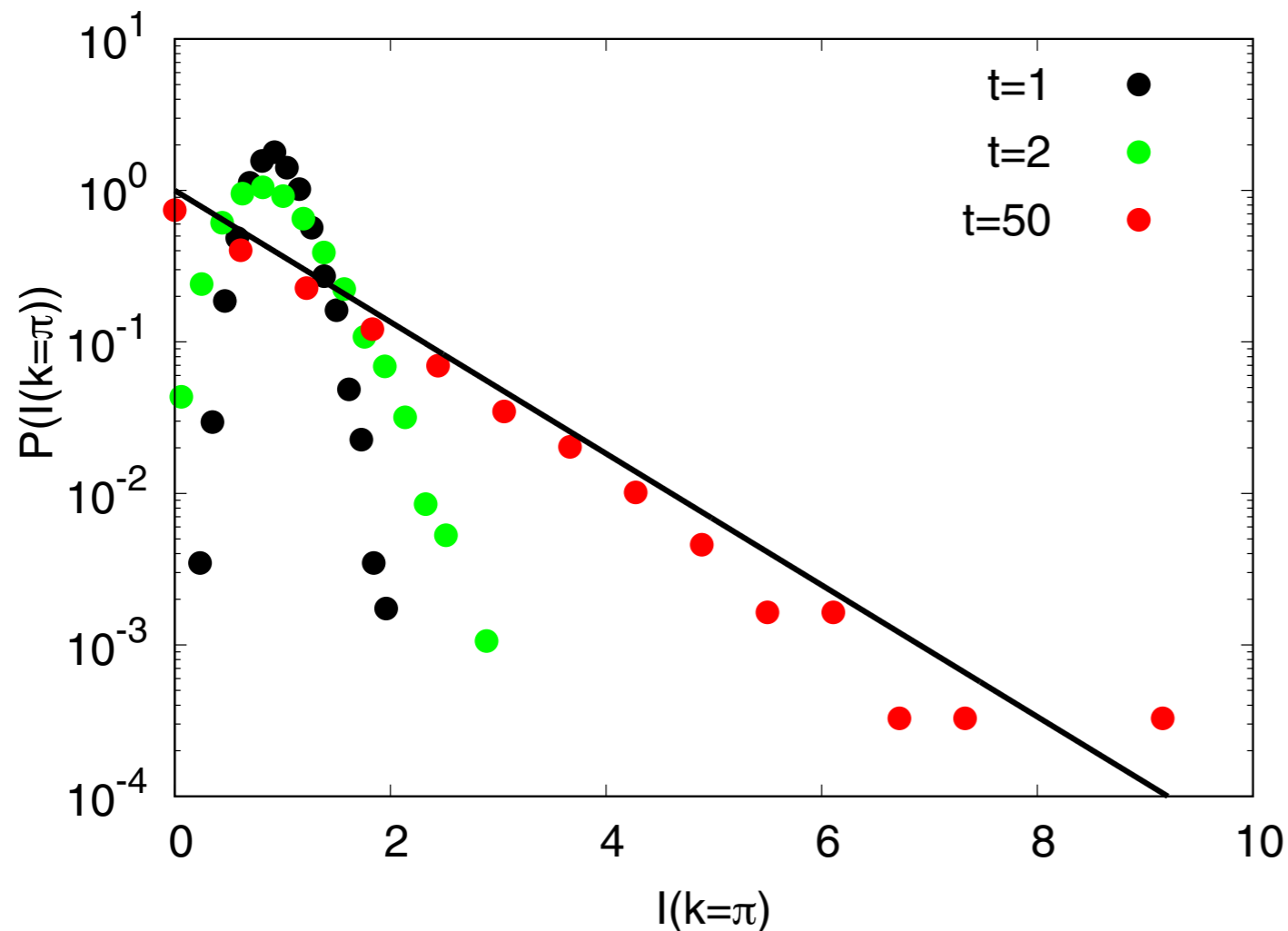

FIG. 6. Probability density function of $I(k = \pi)$ for different times. The dark line corresponds to the exponential distribution derived in Refs. [15,41,46].

- ▶ We tested it for the mode $k = \pi$ in the negative temperature regime
- ▶ The pdf starts to follow the kinetic theory (Rayleigh distributed according to an exponential) at very short time-scale

Another way of testing how quickly the microscopic dynamics approaches the kinetic dynamics is to measure the probability density function of the fluctuations.

CONCLUSIONS

$$i \frac{d\psi_m}{dt} + (\psi_{m+1} + \psi_{m-1} - 2\psi_m) + \nu |\psi_m|^2 \psi_m = 0, \quad m = 1, \dots, M$$

- ▶ Negative temperatures are possible in DNLS due to the (i) **upper bound of the dispersion relation** and (ii) the fact that **the system conserves two quantities**
- ▶ Relations between intensive and extensive quantities can be found in a closed form for DNLS
- ▶ **Negative temperature states are not so exotic**, as their dynamics is very well described (in the weakly nonlinear limit) by WT kinetic theory as well as standard positive temperature states
- ▶ Our conclusions are likely to be valid to any other dispersive wave system characterised by 4-wave interactions where the dispersion relation is bounded from above

PRE 105, 014206 (2022)

THANKS FOR YOUR ATTENTION!

**Joint work with: M. Onorato, G. Dematteis, A. Pezzi, M. Ballarin,
and L. Rondoni**

Acknowledgments

M.O. and L.R. were supported by the “Departments of Excellence 2018-2022” grant awarded by the Italian Ministry of Education, University and Research (MIUR) (Grant No. L.232/2016). G.D. acknowledges funding from ONR Grant No. N00014-17-1-2852. M.O. was supported by Simons Collaboration on Wave Turbulence, Grant No. 617006.